

GENERAC®

PWRCELL

Buyer's Guide

PREPARE FOR POWER OUTAGES.
SAVE MONEY.
POWER YOUR HOME.



**SAVINGS
POWERED
BY THE SUN**



WWW.PWRCELLOFFER.COM



(855) 635-5177

Thank you for considering Generac Power Systems

Since 1959, we have been the leading manufacturer of residential, commercial, industrial and mobile power products. We are proud to have helped millions of customers save money, gain greater independence, and prepare for the unexpected. With innovation rooted in our culture, it's easy to see why Generac is the most trusted brand for power solutions. We design and engineer our products at our facilities in Wisconsin. And our locally-based customer support team is available 24-7/365 – so every customer can feel confident knowing that if support is needed, we will be here to help.

If you're considering adding a solar + battery storage system to your home, you've come to the right place. Generac is pleased to offer the PWRcell, a solar + battery storage system that harnesses energy from the sun to help you be prepared for unexpected power outages, lower your electric utility bill and power your home. We know you have choices, and that there is a lot to learn about these systems. That's why we created the Generac PWRcell Buyer's Guide. It's full of information and can provide answers to questions, such as:

- How can solar + battery storage power my home & help me save money?
- What is a home battery storage system?
- What separates PWRcell from competitive units?
- What does the installation process look like?
- How do I get started?

After reading this guide, and when you are ready to take the next step, request a free quote. We can evaluate your needs and recommend a system that's right for you. Join the millions of satisfied customers who trust Generac. Don't forget to ask about the limited-time special offer valued at \$300!

Thank you for choosing Generac as your trusted resource. If there's anything we can do for you, please give us a call at **855-635-5177** or visit us online at www.PWRcellOffer.com.



Aaron Jagdfeld
President & Chief Executive Officer
Generac Power Systems, Inc.



Power outages & electricity rates are increasing

The electrical power grid continues to age, making it less reliable and more susceptible to power outages that can leave you without lights, refrigeration, Internet access, and in some areas water.

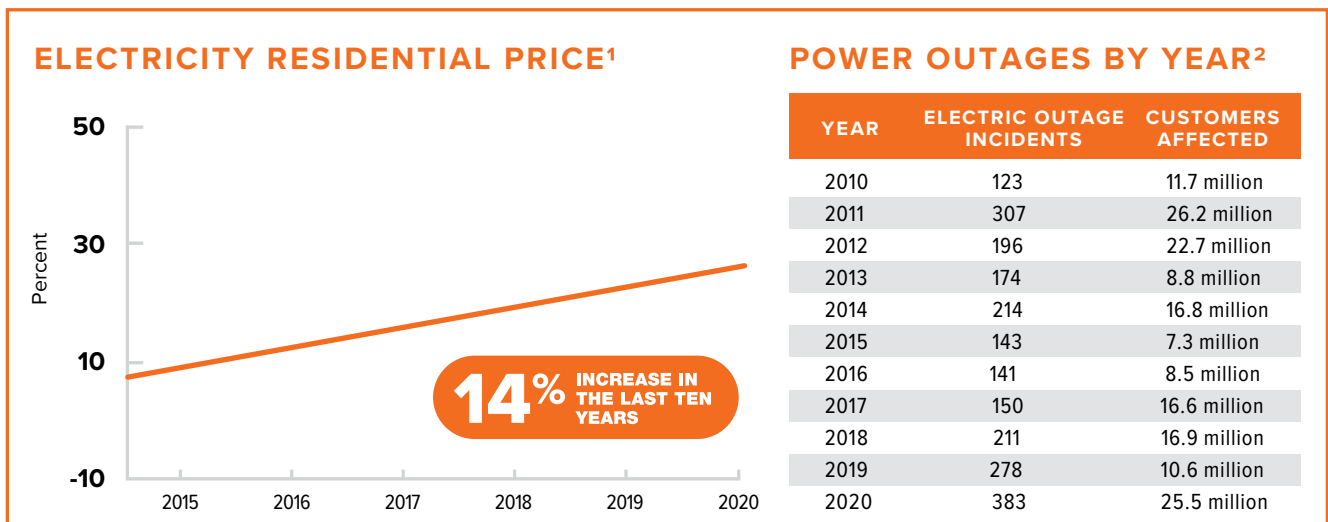

Additionally, electric utility rates are on the rise, with no relief in sight. In the last 10 years, rates have increased 14%.¹ Paying more for electricity can prevent you from investing in the things that matter the most to you, such as:

- Dream vacation
- Home improvement projects
- Financial freedom
- Child's/grandchild's college fund
- Retirement savings

You need an innovative solution that will help you prepare for power outages, lower your monthly electric bill and power your home.

¹Source: EIA (Energy Information Administration)

²Source: 2017 Eaton Blackout Tracker

Be Prepared for Power Outages & Save Money with PWRcell



The Generac PWRcell, a fully integrated solar + battery storage system provides backup power using stored energy from the sun, which helps you save money.



BACKUP POWER

Provides backup power during utility power outages



ENVIRONMENTALLY FRIENDLY

100% emission and fossil fuel free



SAVINGS POWERED BY THE SUN

Use stored energy from solar panels to power your home, which helps you reduce your electric utility costs*



EASY TO INSTALL

Flexible design allows for indoor and outdoor installation

Here's how it works

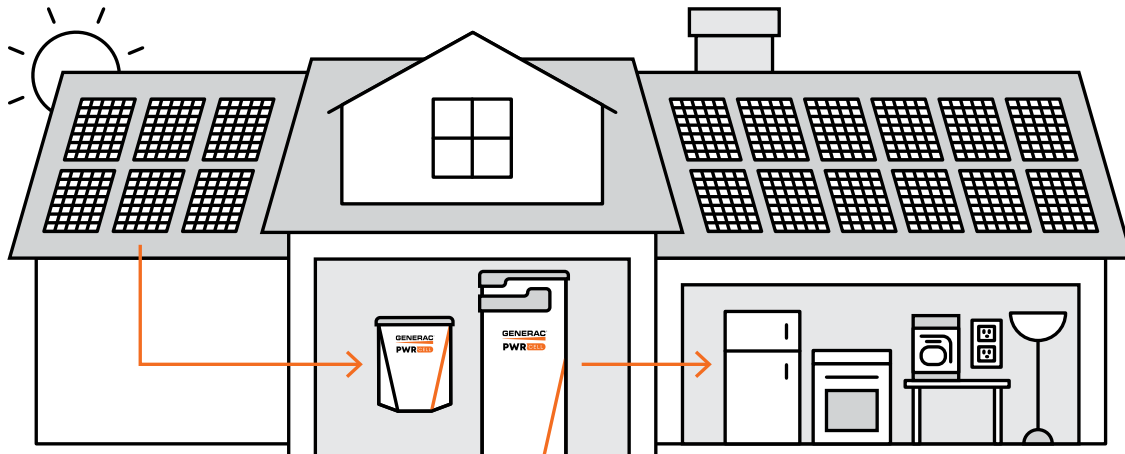

1 PWRcell stores energy from solar panels*

2 Use stored energy to power your home – day or night

3 During a utility power outage, the energy stored in PWRcell can also be used to provide backup power, to help your home and family stay comfortable during a power outage

*PWRcell can also store energy from the electric power grid. Solar panels are sold separately.



The PWRcell System

If you're looking for a fully-integrated solar + battery storage system, the Generac PWRcell is the right solution for you.

The modular Generac PWRcell system provides at least 9kWh of storage capacity and includes:

- 1 Inverter
- 1 Battery storage cabinet
- 3 Lithium ion battery modules
- 10 Year Limited Warranty

PWRcell pairs with solar panels from most manufacturers. Based on your needs and your budget, installation partners can determine the right panels for your home.



Outdoor Rated Battery Storage Cabinet



Inverter



Solar Panels*



Lithium Ion Battery Modules



Included with the PWRcell!

CUSTOMIZABLE OPTIONS & EASY INSTALLATION

The Generac PWRcell features a modular design that allows you to expand your storage capacity as your power needs evolve. This flexibility allows you to start out with a 9kWh solar + battery storage system and expand in increments of 3kWh, up to 36kWh with two battery cabinets.

PWRcell's flexible design allows for indoor and outdoor installations. Best of all, each component from the batteries to the inverter, down to the rapid shutdown device and solar array performance optimizers, are designed by Generac to work seamlessly together, making PWRcell easier and faster to install.

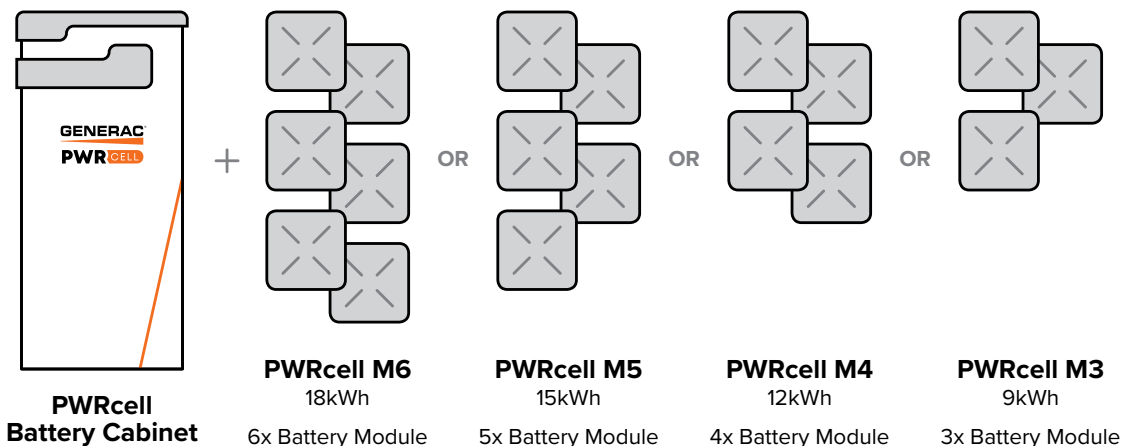

*Solar panels are sold separately.

Why PWRcell?

PWRcell outshines the competition

PWRcell offers 30% more power output than our competitors,* and it offers more storage capacity, so you can run more than just the essentials. By not sacrificing comfort or convenience, PWRcell keeps your home a sanctuary during a power outage. Plus, you'll also save on utility bills when you power more with free sunshine.

		PWRcell	Powerwall+ **	% More
Stores more sunshine	Usable storage capacity [kWh]	18	13.5	33%
More on-grid power	Maximum continuous power on-grid [kW]†	7.6	5.8	31%
More off-grid power	Maximum continuous power off-grid [kW]†	9	7	29%

*Figure based on single storage cabinet of battery modules. **Tesla specifications per Tesla Powerwall specification sheet.
† Battery only, no contribution from solar.

Save money with PWRcell

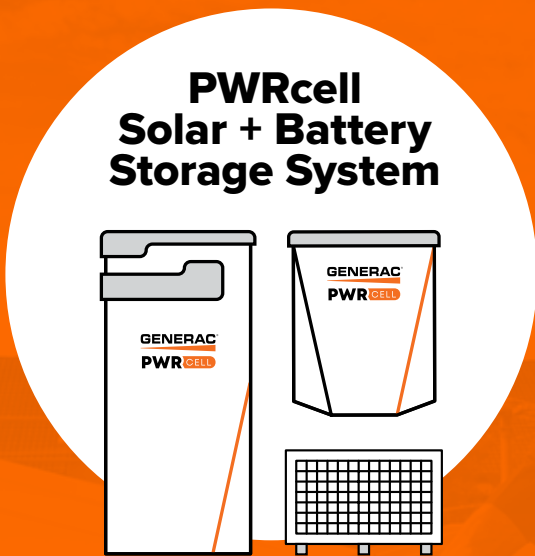

\$64,217*
in estimated savings over 25 years!

Cost & Savings Breakdown

- \$18K** **9kWh PWRcell System**
Cost of installation included
- \$29K** **Solar Panels**
Cost of 22 solar panels (7.7 kWh) and installation
- \$350** **Monthly Utility Bill**
Home without solar + storage
- \$191** **Monthly Utility Bill with Solar Storage***
Plus equipment financing
- \$159** **Monthly Savings***
Estimated savings per month
- 26%** **Solar Tax Credit****
That can be claimed by installing solar by the end of 2022

*Excludes repair or replacement of components outside of warranty.

**Not everyone is eligible for the federal and state tax credits/rebates or can use them. Please consult your tax or legal professional for more details.

*Assumes a 25-year loan with a 4% fixed interest rate with a principal of \$43,544. This is not an offer for financing. For special financing, contact a Generac installer.

*Monthly electric utility bill per month based on a customer testimonial. Example based on a 3,000-square foot home in San Diego, CA. Savings and system production will vary based on final design, utility rates, and household energy usage. The actual savings vary based on a number of factors, including weather, shading from growing trees, system components, future electricity use, and the fluctuation of the price of electric in the utility district. Assumes an annual electric utility rate increase of 2.39% (Source: U.S. Energy Information Administration).

Getting Started

HOW MUCH DOES PWRCELL COST?

The PWRcell battery storage system starts at just **\$12,435 MSRP***.

At this price, you will receive:

- 3 battery modules that provide 9 kilowatt hours (kWh) of energy
- 1 battery storage cabinet
- 1 inverter

Generac's authorized installers can help you determine which solar panels to pair with the PWRcell system to help achieve optimal performance and efficiency.

Special financing with \$0 down options are available through one of Generac's recommended finance partners². You may also qualify for state or federal rebates, tax credits, or other financial incentives, making the PWRcell even more affordable³.

WHAT SIZE SYSTEM IS RIGHT FOR ME?

The Generac PWRcell offers a modular design for easy customization that meets most customers' needs. Generac recommends that you work with an authorized installer given the number of configurations available.

When you partner with an authorized Generac installer, you are working with a licensed, experienced local professional who has expertise installing the Generac PWRcell solar + battery storage system. They will be knowledgeable about potential local and federal rebates and financial incentives, municipal permitting, electrical code requirements, and installation requirements.

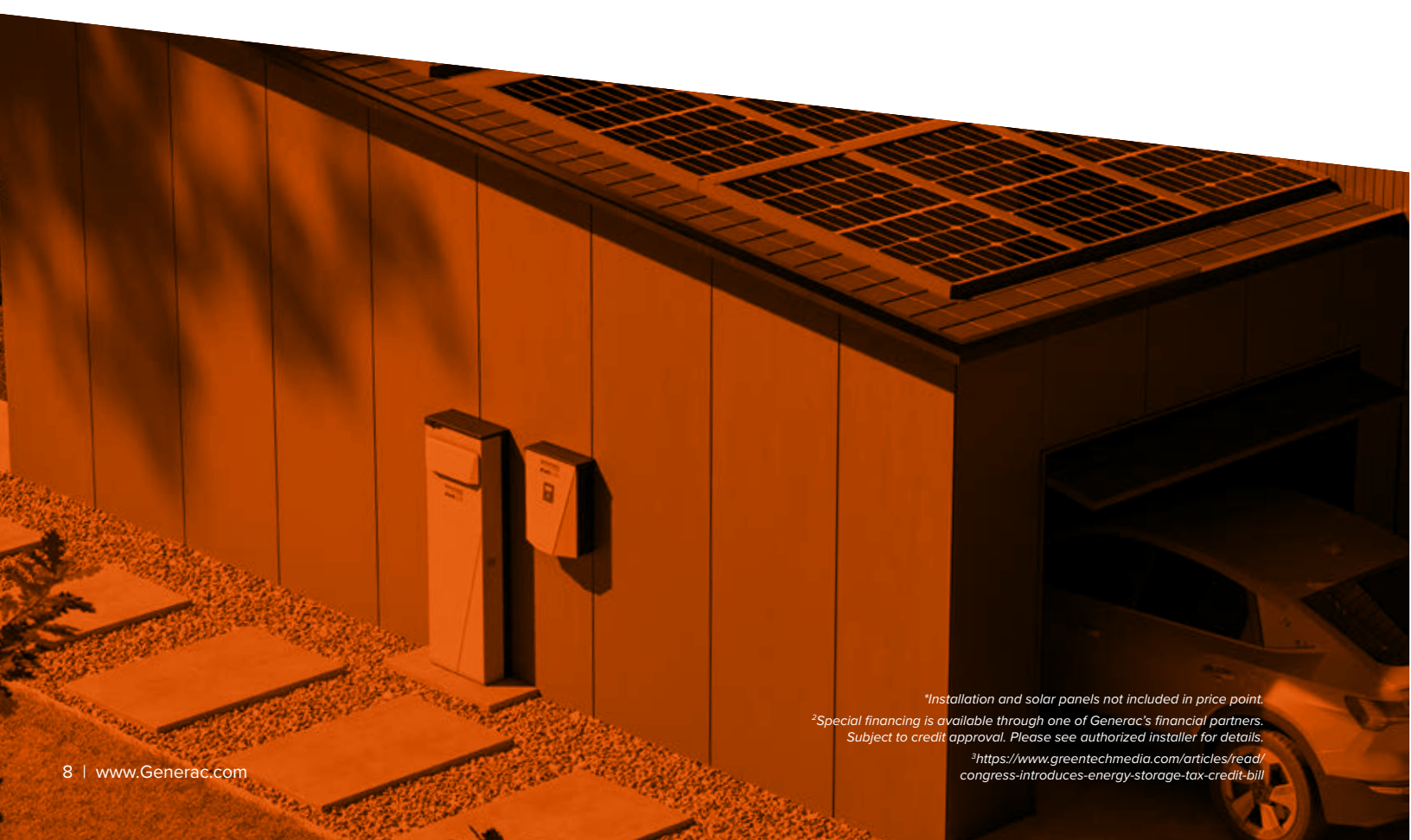

¹Installation and solar panels not included in price point.

²Special financing is available through one of Generac's financial partners. Subject to credit approval. Please see authorized installer for details.

³<https://www.greentechmedia.com/articles/read/congress-introduces-energy-storage-tax-credit-bill>

GENERAC®

PWRVIEW

HOME ENERGY MONITORING

Another way to help reduce your electric utility bill and gain greater energy independence is to use Generac's premier home energy monitoring app, PWRview. Easily access your home's energy information from your smartphone, tablet or computer from anywhere in the world.

With PWRview, your energy information is right at your fingertips. You can:

- Learn how your daily habits impact your electricity costs
- Receive detailed bill tracking and forecasting
- Track the status of your battery system to ensure energy is available during peak demand times and utility power outages
- Understand how PWRcell helps you meet your energy needs and reduce grid dependence with daily energy dashboards and summaries



The PWRview app is available for download on Apple® and Android™ devices.



ACT NOW!

LIMITED-TIME OFFER

Request a free PWRcell quote and receive PWRview - Generac's premiere home energy monitoring system, with your purchase - **A \$300 VALUE!**[§]



WWW.PWRCELLOFFER.COM



(855) 635-5177

[§]Based on purchasing PWRview separately
www.Generac.com | 9



Whole home power outage protection

Power outages are unpredictable, inconvenient and disruptive. They are also occurring more frequently and lasting longer. During a power outage, there are no lights, no refrigeration, no Internet access, and in some areas, no water. However, when you have PWRcell, you stay comfortable and your home remains your sanctuary.

When PWRcell is paired with the PWRcell™ Automatic Transfer Switch (ATS) and Smart Management Modules (SMMs), your system will automatically send power to the appliances that need it most, allowing you to power more than just the essentials during a utility power outage. This complete system can generate up to 80% more continuous power than competitive units.

To further strengthen the whole-home capabilities of the PWRcell system, Generac has also introduced the PWRgenerator and PWRmanager. PWRgenerator is a DC-coupled backup generator designed to recharge your PWRcell batteries, while PWRmanager, is an advanced load management system designed to increase the performance of your battery.

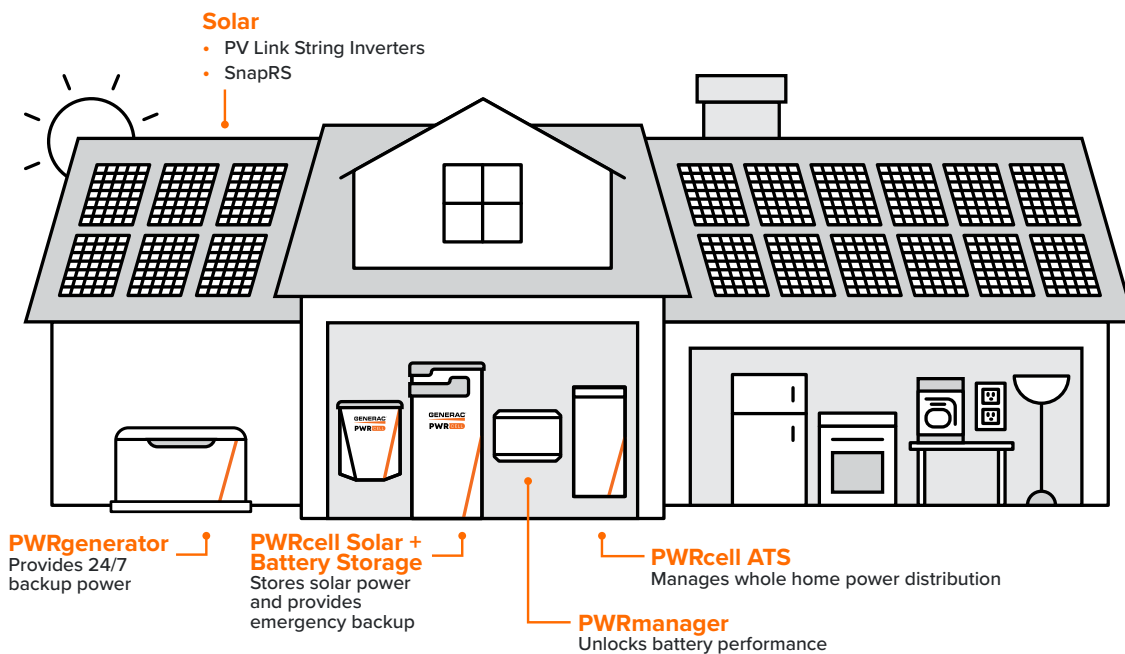

Automatic Transfer Switch

An integrated solar + battery storage system with load management for whole home coverage is made easy with the PWRcell™ Automatic Transfer Switch (ATS). Power your home and manage up to four individual HVAC (24 Vac controlled) loads with the PWRcell ATS.



PWRgenerator

When sunlight is unavailable or insufficient, the DC-coupled PWRgenerator rapidly recharges PWRcell's batteries to keep the home powered long-term when there's a utility power outage.



Advanced Load Management

PWRmanager

The PWRmanager advanced load management device adds unbeatable flexibility and value to the PWRcell System. Controlled via the user-friendly PWRview app, PWRmanager gives the homeowner access to choose what loads they want to power during an outage while automatically managing those loads to conserve energy and extend your system's battery life to last through the outage.



Load Management

Smart Management Modules

Generac's Smart Management Modules (SMMs) allow PWRcell to make the most of its leading backup power capabilities and capacity by helping to prevent system overload and allowing lockout of select connected loads for power usage management during a utility outage.



PV Link

Optimizer

Each PV Link allows you to connect 2 to 9 solar PV modules, enabling you to build a flexible, easy-to-install solar array.



SnapRS

Rapid Shutdown Device

SnapRS is an in-line disconnect device that helps to satisfy module-level rapid shutdown requirements.

SOLAR PANEL CAPABILITY

The PWRcell system can be paired with most DC solar panels (sold separately).

MEETS NATIONAL ELECTRIC CODE (NEC) RAPID SHUTDOWN REQUIREMENTS

SnapRS and PV Link Optimizers meet NEC 2017 and NEC 2020 PV rapid shutdown requirements.

PROTECTS EQUIPMENT

SnapRS and PV Link Optimizers are listed to UL 1741. PV Link automatically detects arc and ground faults.

Here's what our customers have to say about PWRcell

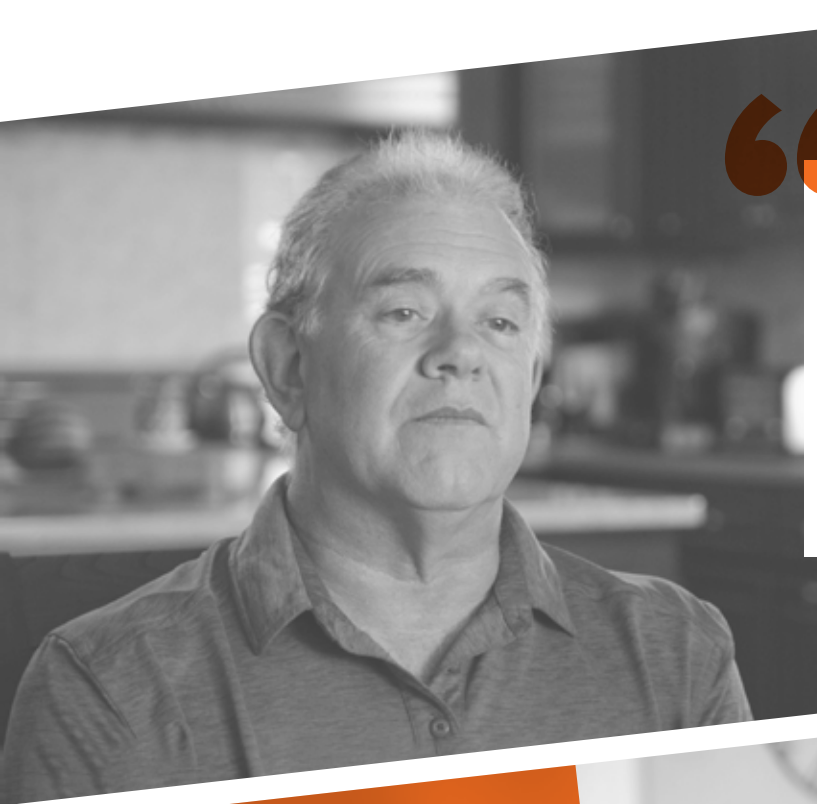

“

It was a simple installation but done very quickly and efficiently... Since installing our power system, **we've been experiencing a savings of \$1,500 a year.**

- JOHN D., SAN CLEMENTE, CA

”



“

The battery storage solution in combination with the solar has been one of the best investments we've ever made... **We're saving about \$450 a month.**

- RYAN M., ESCONDIDO, CA

”

Take the next step!

To get started, call or go online to request a **FREE quote**. One of Generac's authorized installers will work with you to design a system that will power your home, help lower your electric bill and help you prepare for utility power outages.

**AVAILABLE
NOW! READY
TO INSTALL!**

ACT NOW!

LIMITED TIME OFFER VALUED AT \$300*



WWW.PWRCELLOFFER.COM



(855) 635-5177

*When purchased separately at retail



Preparation Worksheet



To help you prepare for your free quote, Generac has compiled a list of questions for you to consider. **Please have your latest utility bill available at your appointment.**

BE PREPARED TO DISCUSS:

1. Why are you interested in the PWRcell solar + battery storage system?

- Do you want to reduce your electric utility costs? **Y** / **N**
- Do you want to reduce your dependence on the electrical grid? **Y** / **N**
- Do you want backup power during unexpected power outages? **Y** / **N**
- Do you want an ecofriendly solution to help you save money and keep your home protected? **Y** / **N**
- Do you plan on participating in net metering to sell excess power back to the grid? **Y** / **N**

2. How much would you like to reduce your electricity bill by each month?

3. How many square feet is your home?

4. Do you use most of your electricity during the day or at night?

5. What is your budget for a battery storage system?

QUESTIONS TO ASK:

1. How many hours can the PWRcell solar + battery storage system run my home?
 - a. How long can it power my home during power outages?
2. How can PWRview help me save even more money each month?
3. If I already have solar panels, can I still install PWRcell?
4. Do you offer financing options?
5. Do you have information on available state and federal rebates and tax credits, and how those incentives can help reduce my costs?
6. Do I need a bi-directional meter and approval from the energy company to sell excess power back via net metering?

SAVINGS POWERED BY THE SUN



For more information or
to request a free quote,
call or go online:

 (855) 635-5177

 WWW.PWRCELLOFFER.COM

Generac Power Systems, Inc.
S45 W29290 Hwy. 59, Waukesha, WI 53189

www.Generac.com | 888-GENERAC (436-3722)

201901300 REV 6/22

©2022 Generac Power Systems. All rights reserved.
Specifications are subject to change without notice.

GENERAC®